

Department of Health & Social Services
 FY2017 Operating Budget
 Health Care Services
 Medical Assistance Administration
 Management
 PFT: 2 PPT: 0 NP: 0
 ANC: 1 JUN: 1

HEALTH CARE SERVICES MANAGEMENT

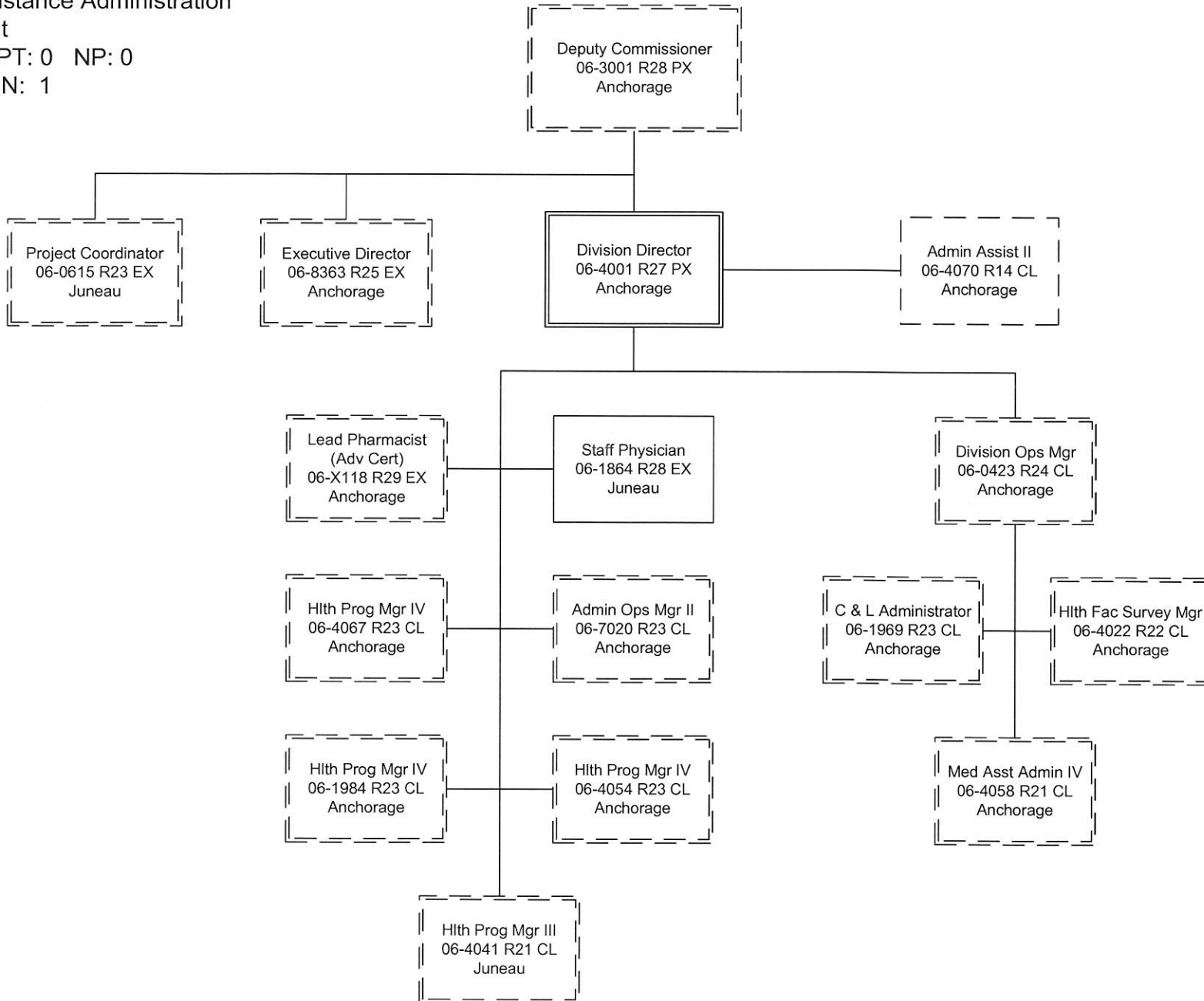

Department of Health & Social Services
FY2017 Operating Budget
Health Care Services
Medical Assistance Administration
PFT: 8 PPT: 0 NP: 0
ANC: 6 JUN: 2

ADMINISTRATIVE STAFF

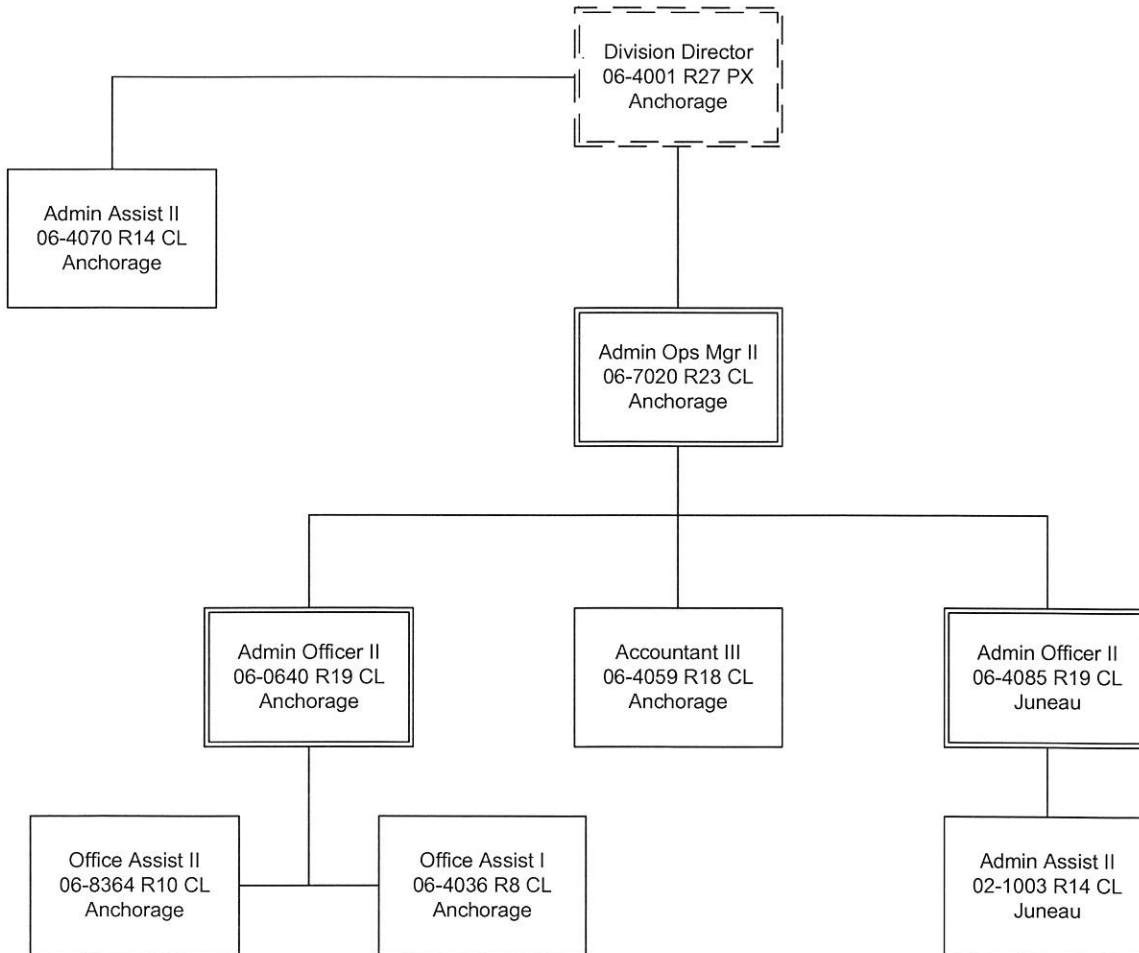

Department of Health & Social Services
FY2017 Operating Budget
Health Care Services
Medical Assistance Administration
PFT: 12 PPT: 0 NP: 0
ANC: 12 JUN: 0

ACCOUNTING & RECOVERY

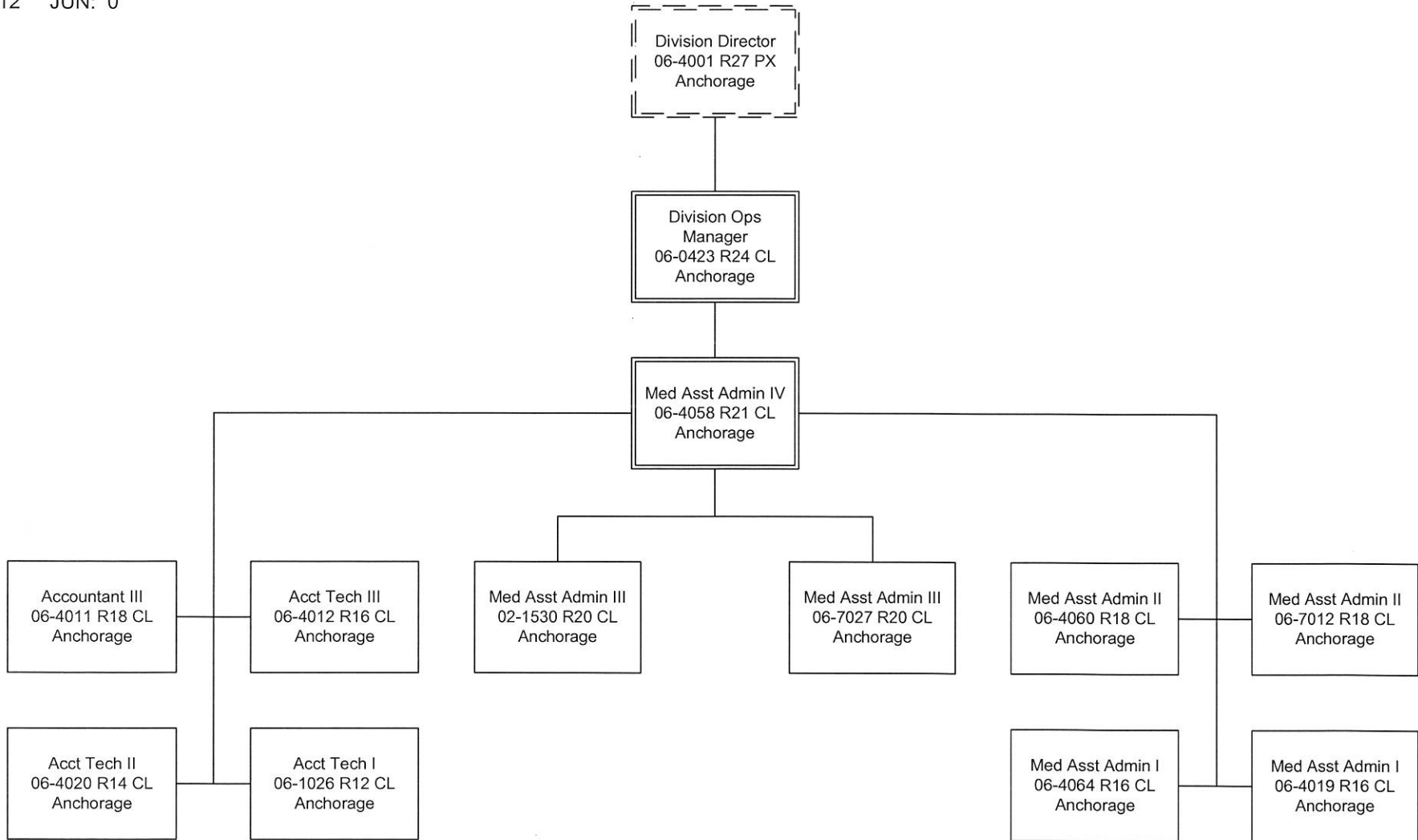

Department of Health & Social Services
 FY2017 Operating Budget
 Health Care Services
 Medical Assistance Administration
 PFT: 15 PPT: 0 NP: 0
 ANC: 15 JUN: 0

MEDICAID MANAGEMENT INFORMATION SYSTEM &
 DECISION SUPPORT

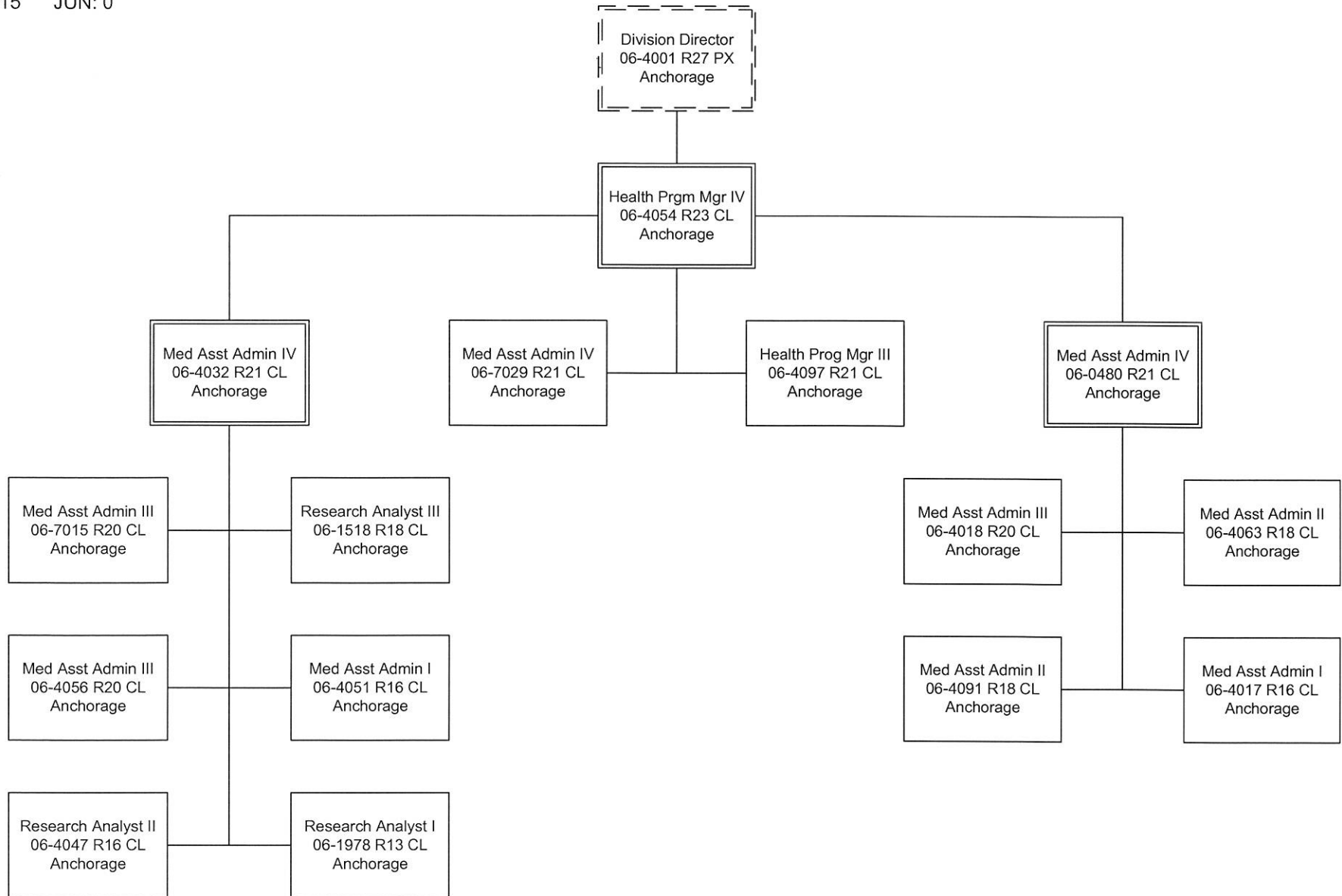

Department of Health & Social Services
FY2017 Operating Budget
Health Care Services
Medical Assistance Administration
PFT: 2 PPT: 0 NP: 1
ANC: 3 JUN: 0

HEALTH INFORMATION TECHNOLOGY

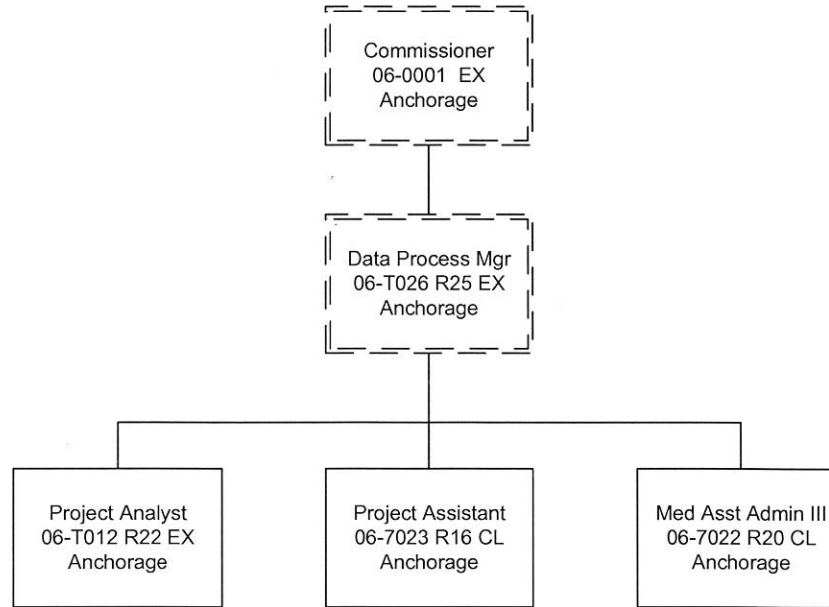

Department of Health & Social Services
FY2017 Operating Budget
Health Care Services
Medical Assistance Administration
PFT: 4 PPT: 0 NP: 0
ANC: 4 JUN: 0

PHARMACY & ANCILLARY

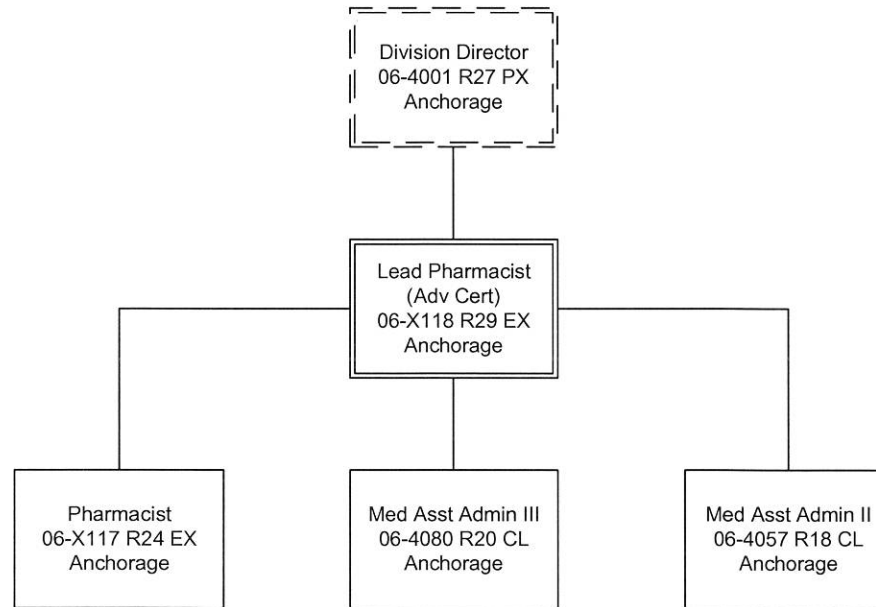

Department of Health & Social Services
FY2017 Operating Budget
Health Care Services
Medical Assistance Administration
PFT: 13 PPT: 0 NP: 0
ANC: 13 JUN: 0

OPERATIONS

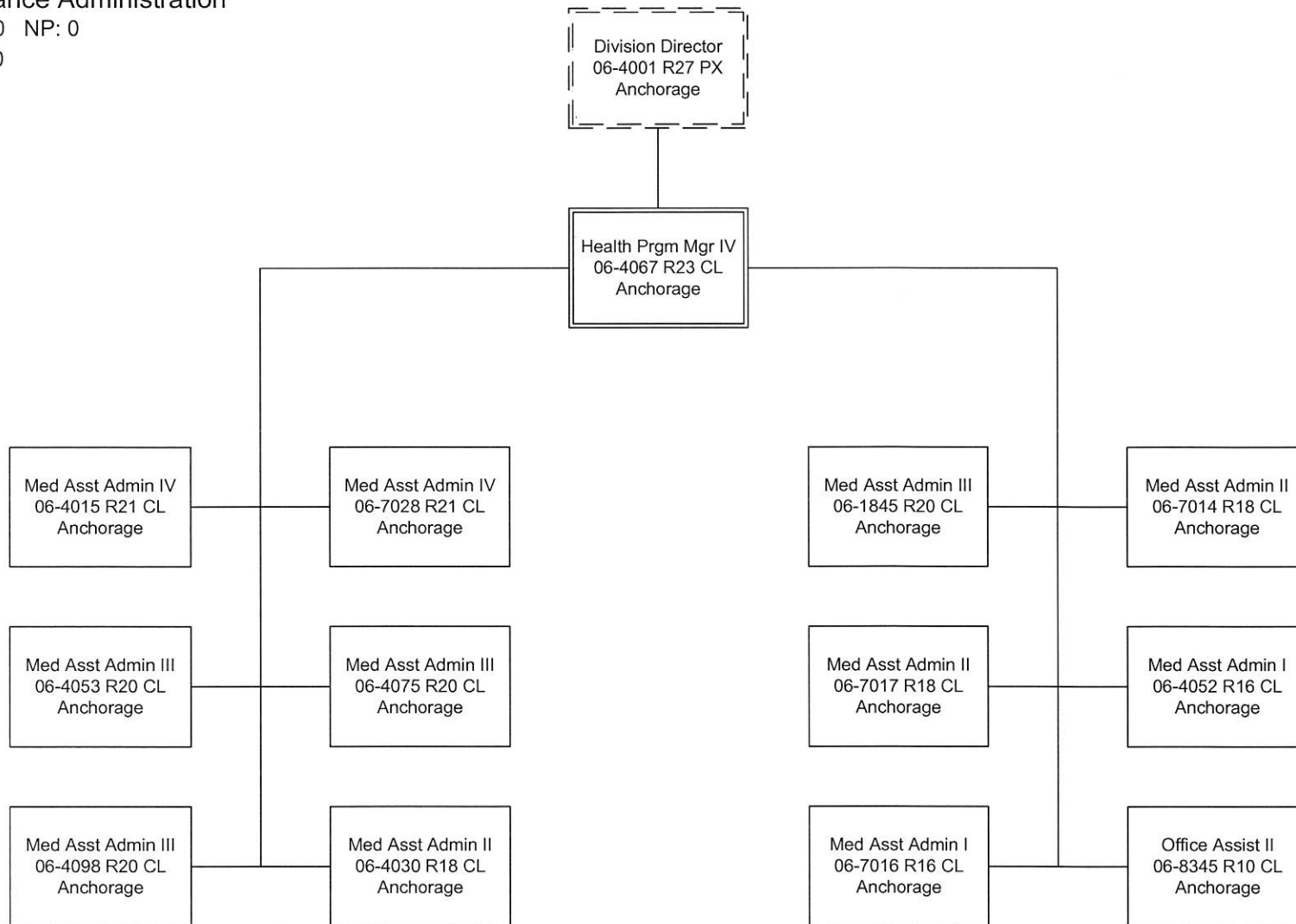

Department of Health & Social Services
FY2017 Operating Budget
Health Care Services
Medical Assistance Administration
PFT: 9 PPT: 0 NP: 0
ANC: 9 JUN: 0

QUALITY ASSURANCE

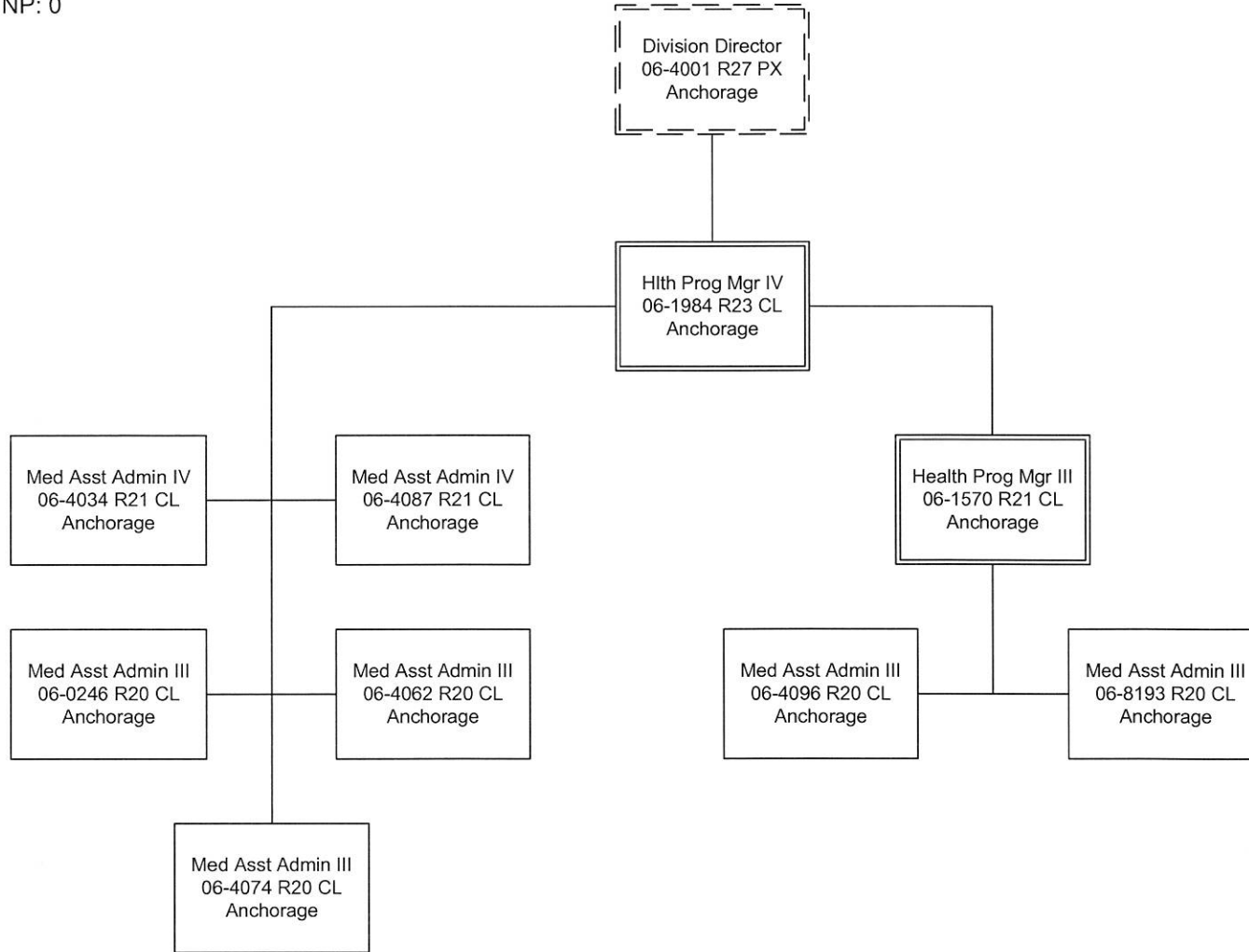

Department of Health & Social Services
FY2017 Operating Budget
Health Care Services
Medical Assistance Administration
PFT: 3 PPT: 0 NP: 0
ANC: 1 JUN: 2

PROGRAM REVIEW - MEDICAID

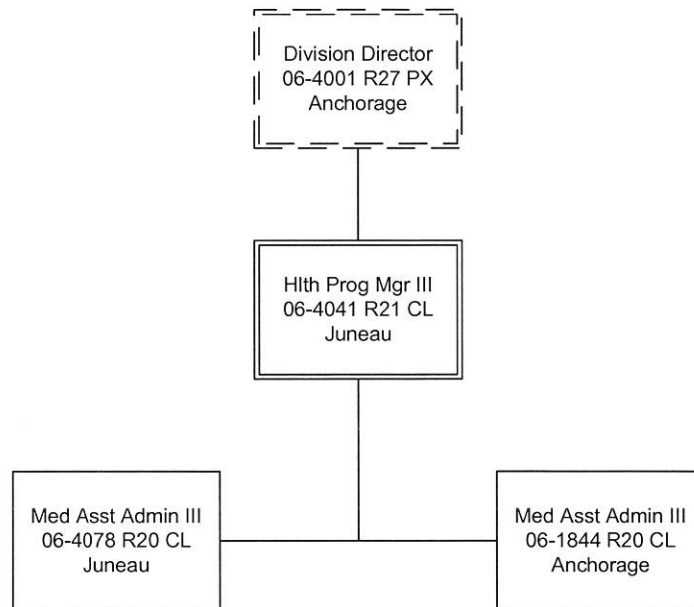

Department of Health & Social Services
FY2017 Operating Budget
Health Care Services
Medical Assistance Administration
PFT: 2 PPT: 0 NP: 0
ANC: 1 JUN: 1

PROGRAM REVIEW - TRIBAL

